

curve  
ficha técnica  
datasheet

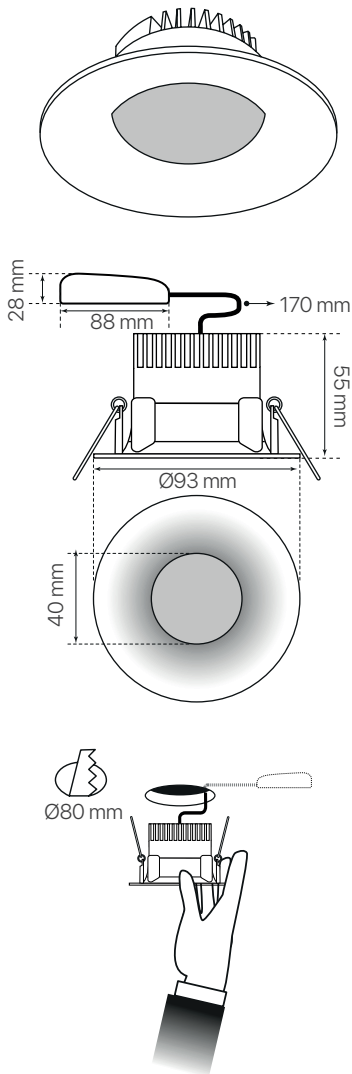

ref. 5550175



Nombre / Name	curve
Referencia / Reference	5550175
Materiales / Materials	Aluminio / Aluminum
Difusor / Diffuser	PMMA
Potencia / Power	8W
Temperatura de color / Color temperature	3000K
Flujo luminoso / Luminous flux	500lm
Dimable / Dimmable	No
Ángulo de apertura / Beam angle	60°
Ángulo de inclinación / Inclination angle	-
IP	20
IK	-
F.P	-
UGR	-
IRC	-
Chip	EPISTAR SMD
Driver	i-TEC series
Vida media ( duración ) / Average life	30.000 ~ 50.000h
Clase energética / Energy class	A
Aislamiento eléctrico / Electrical isolation	-
Colores / Colors	Blanco / White
Medida exterior / Product size	Ø93mm x 55mm
Medidas de corte / Cutting measurements	Ø80mm
Tª ( ambiente/trabajo ) / Tª ( enviroment/work )	-20°C ~ 40°C
Input	AC100 ~ 240V
Output	DC9 ~ 12V 670mA
Frecuencia / Frequency	50 / 60Hz
Peso / Weight	260g
Certificados / Certificates	CE
Garantía / Warranty	2 años / 2 years